

IRDC3622D

USER GUIDE FOR DUAL OUTPUT IRDC3622D EVALUATION BOARD USING IRF6622 AND IRF6629 DIRECTFET MOSFETS

Table of Contents

	Page
Description	1
Board Features	1
Connections & Operating Instructions	2
Layout	5
Schematic	10
Bill of Materials	11
Waveforms	12
Synchronization	21
Voltage & Tracking	22
MLPQ Package	24

USER GUIDE FOR DUAL OUTPUT IRDC3622D EVALUATION BOARD USING IRF6622 AND IRF6629 DIRECTFET MOSFETS

DESCRIPTION

This user guide contains the schematic and bill of materials for the IRDC3622D evaluation board. The guide describes operation and use of the evaluation board itself. The IR3622 IC is a dual channel synchronous buck controller, providing a cost-effective, high performance and flexible solution. The two channels can be configured to either two independent outputs or current sharing single output. The current share configuration is ideal for high current applications.

Key features offered by the IR3622 include configurable dual output, output voltage tracking, power up/down sequencing, programmable soft-

start ramp, pre-bias start-up, latched over-voltage protection, thermal protection, accurate reference voltage, on-board regulator, threshold sensitive Enable input, programmable switching frequency up to 600kHz, and input under-voltage lockout for proper start-up.

An output over-current protection function and a hiccup current limit are implemented by sensing the voltage developed across the on-resistance of the synchronous rectifier MOSFET for optimum cost and performance. Detailed application information for the IR3622 integrated circuit is available in the IR3622 data sheet.

BOARD FEATURES

- The board is designed for two output voltages 2.5V and 1.8V up to 20A for each output.
- $V_{IN} = +12V$, (13.2V Max)
- $V_{O1} = +2.5V \pm 3\% @ 20A$, $V_{O2} = +1.8V \pm 3\% @ 20A$
- $V_o(\text{ripple}) = 50\text{mV}$ maximum for each output
- $F_s = 350\text{kHz}$
- $L1 = 990\text{nH}$, $L2 = 540\text{nH}$
- $C_{O1} = 2 \times 100\mu\text{F}$ (SP) + $2 \times 10\mu\text{F}$ (ceramic 0805) for 2.5V output
- $C_{O2} = 2 \times 220\mu\text{F}$ (SP) + $2 \times 10\mu\text{F}$ (ceramic 0805) for 1.8V output
- The input voltage start threshold of the converter is set about 10V using enable pin and two external resistors (R16A1 and R16A2).
- The converter has the option to sequence with other supplies using SEQ and Track pins (R6A1, R16A3 and R16A4). These pins are pulled high as default.

CONNECTIONS and OPERATING INSTRUCTIONS

Input Supplies Connection:

Two supplies are required for this board, 3.3V and 12V. Both supplies should be well regulated. The 3.3V supplies the pull-up resistor for Power Good. The Track and Seq pins are also pulled high using 3.3V. Connect the 3.3V supply to TP1(+) and TP2(Gnd). The 12V supply is the bus voltage; It also biases IR3622 IC and should be able to source 10A current. Connect this supply either to 8-pin connector (J1A) or solder other connectors, such as banana jacks, to the exposed pads.

Note: For correct start up the 3.3V supply needs to be powered first.

Output Load Connection:

The load can be connected to the large screw-terminals or solder other connectors, such as banana jacks to the exposed pads.

Table I. Connections

Signal Name	Connection
+3.3V Supply	TP1
Ground of the 3.3V Supply	TP2
V_{IN} (+12V)	J1A
Ground of V_{IN}	
V_{O1} (+2.5V)	TB1A
Ground of V_{O1} (+2.5V)	TB2A
V_{O2} (+1.8V)	TB3A
Ground of V_{O2} (+1.8V)	TB4A

CONNECTION DIAGRAM

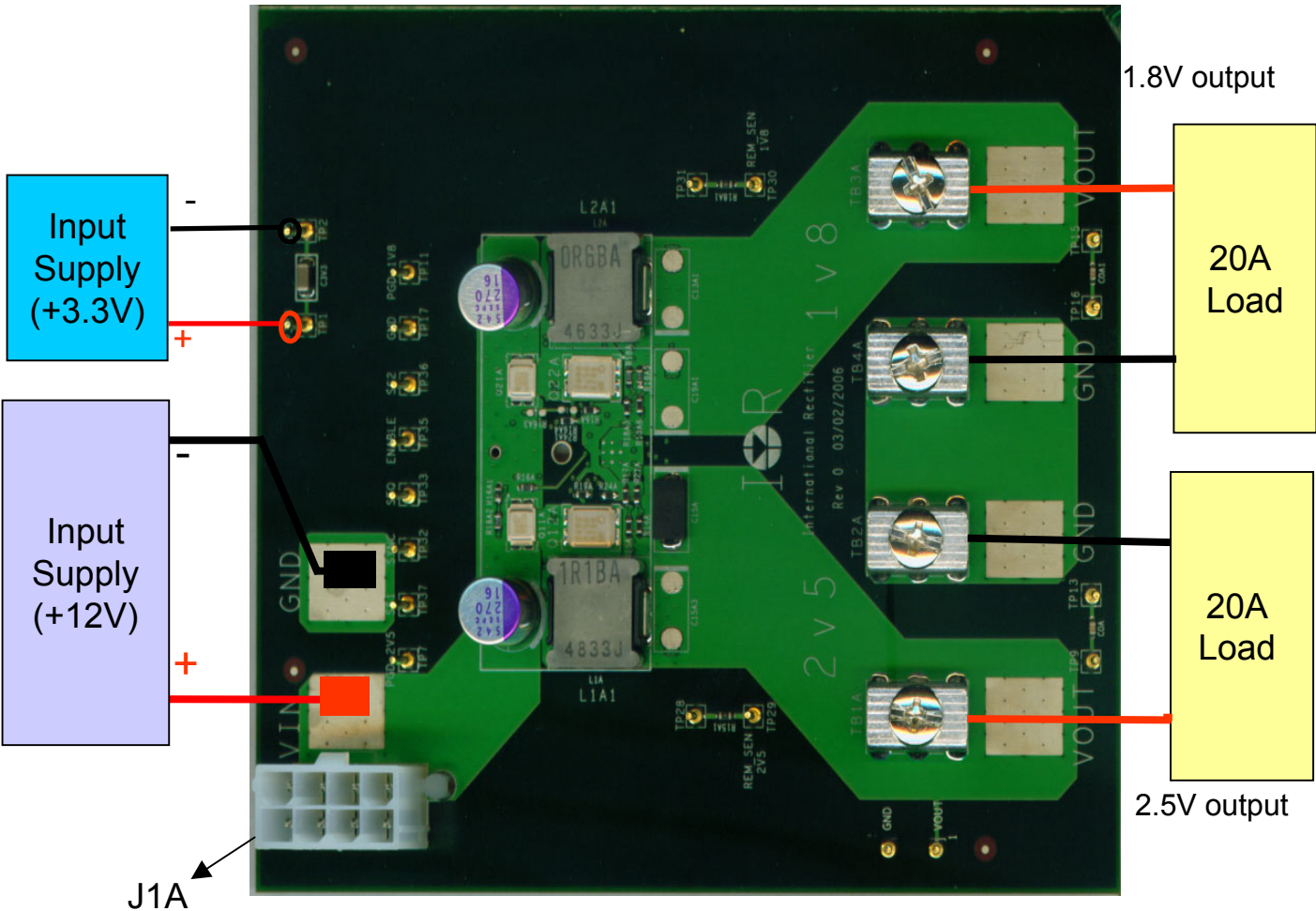

Fig. 1: Connection diagram of the IRDC3622D evaluation board.

Test Points

Input, output, and control signals are accessible through test points as listed in Table II.

Table II. Test Points

Test Point	Signal Name	Description
TP37	SS1	Soft Start for 2.5V output
TP36	SS2	Soft Start for 1.8V output
TP32	SYNC	External Synchronization signal
TP33	SEQ	Enable input for Sequence and Tracking
TP7	PGD_2V5	Power Good output for the 2.5V output
TP11	PGD_1V8	Power Good output for the 1.8V output
TP17	GND	Ground
TP35	Enable	Enable input of the 3622 IC
TP9, TP13, TP21, TP22	V _{o1} (2.5V)	Output voltage and ground for the 2.5V output
TP15, TP16	V _{o2} (1.8V)	Output voltage and ground for the 1.8V output
TP28, TP29	REM_SEN2V5	Remote Sensing at terminal block for the 2.5V output
TP30, TP31	REM_SEN1V8	Remote Sensing at terminal block for the 1.8V output

LAYOUT

The IRDC3622D is an eight-layer board. The top and bottom layers are 2 Oz. copper and the internal layers are 1 Oz. copper. The switching MOSFETS, Inductors, 270uF input capacitors, output capacitors, and some smaller passive components are mounted on the top side of the board. The IR3622 IC and the rest of passive components are mounted on the bottom layer. The DirectFET technology is used for MOSFETs.

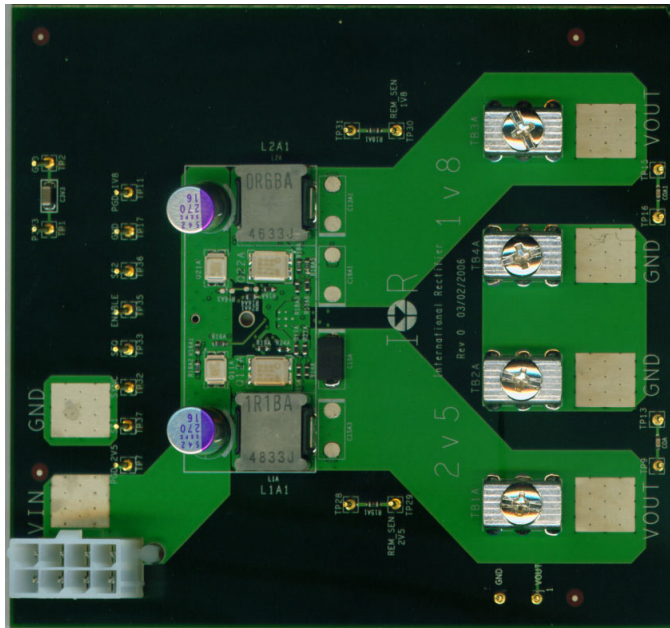

Fig. 2: Parts placement, the top layer.

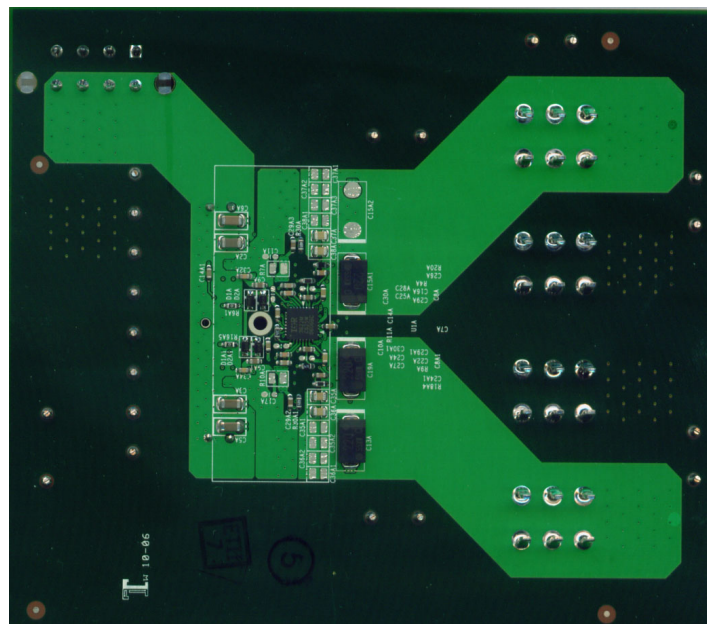

Fig. 3: Parts placement, the bottom layer.

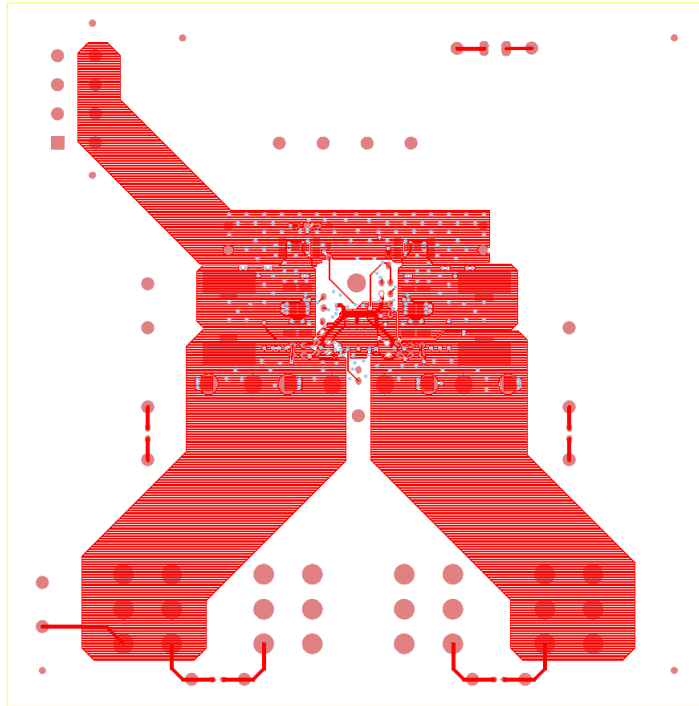

Fig. 4: Board layout, top layer.

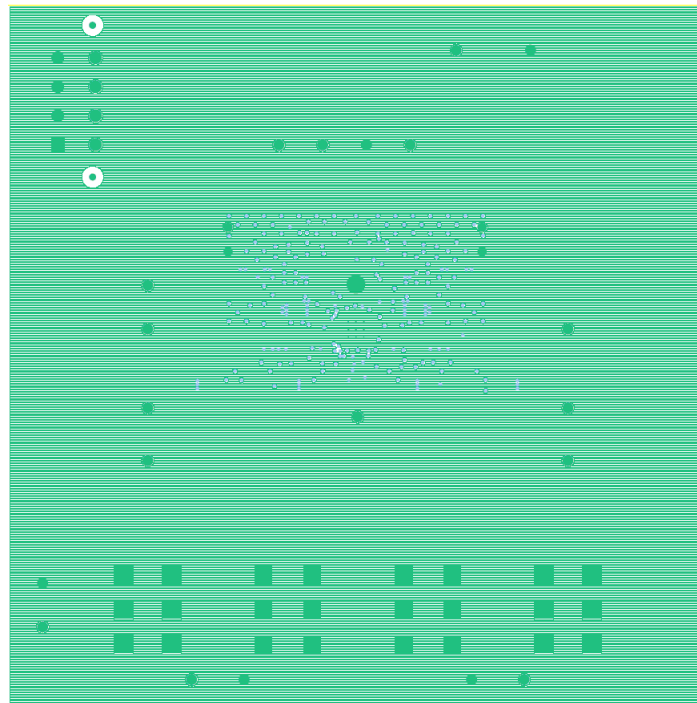

Fig. 5: Board layout, mid layer 1.

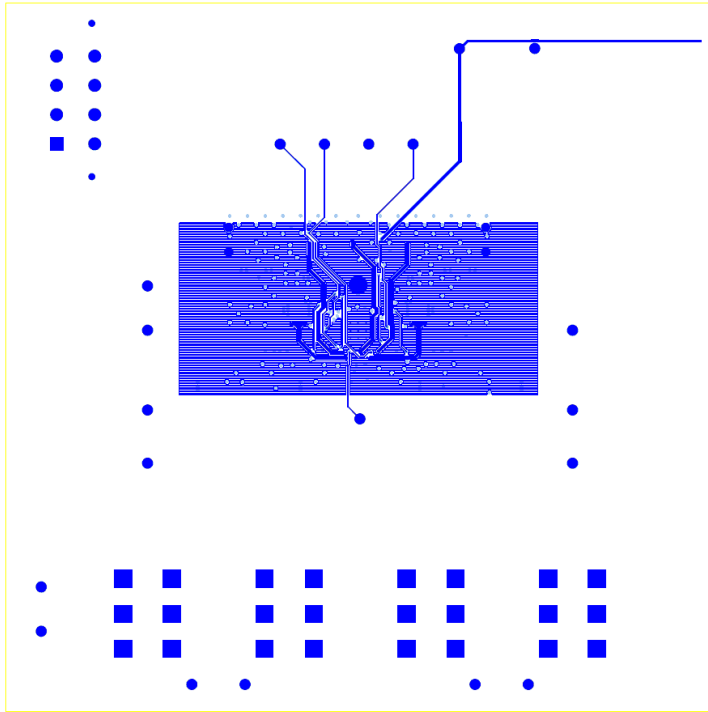

Fig. 6: Board layout, mid layer 2.

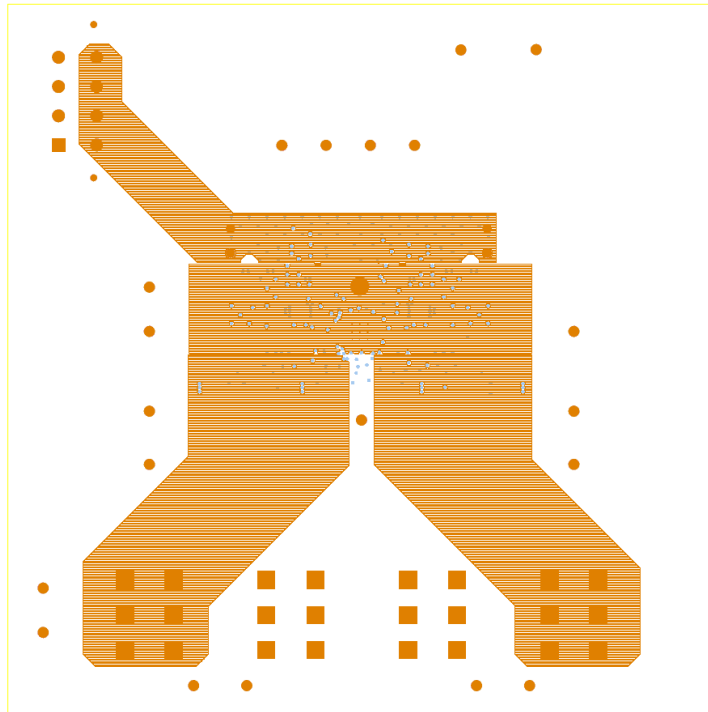

Fig. 7: Board layout, mid layer 3.

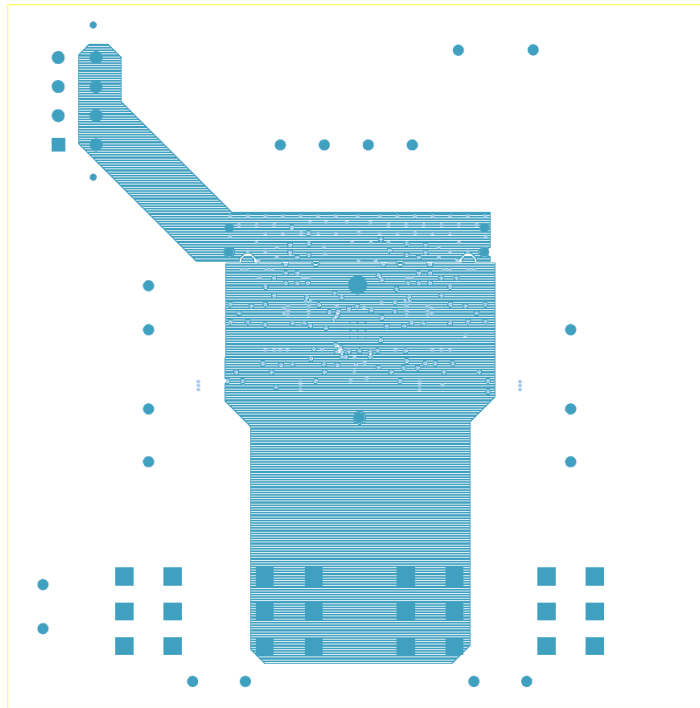

Fig. 8: Board layout, mid layer 4.

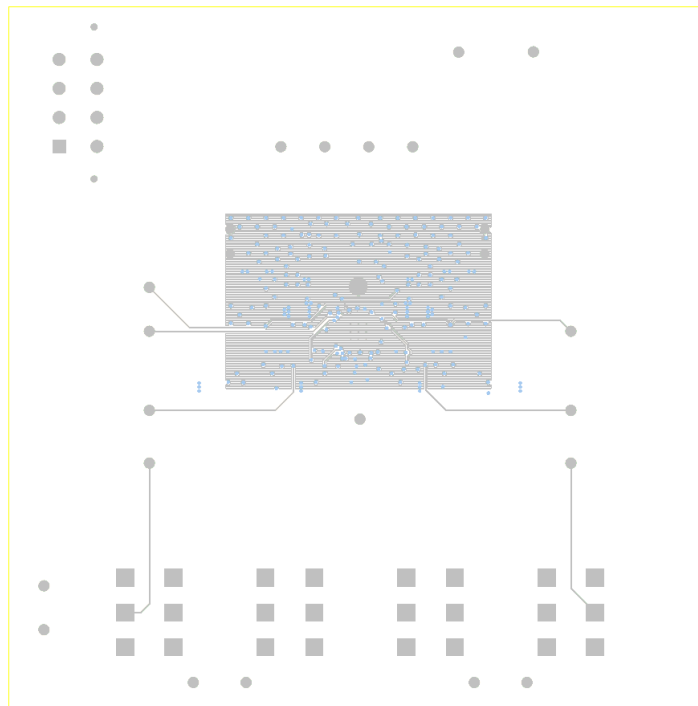

Fig. 9: Board layout, mid layer 5.

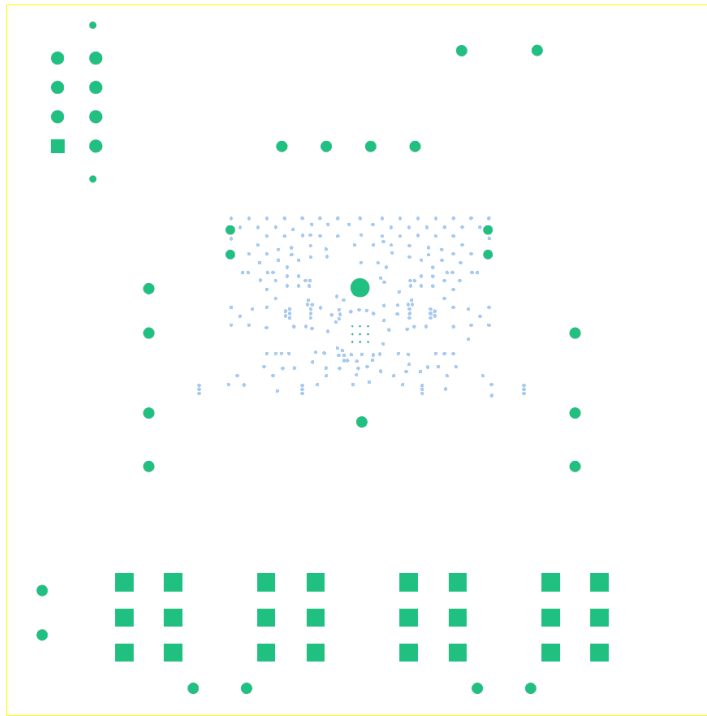

Fig. 10: Board layout, mid layer 6.

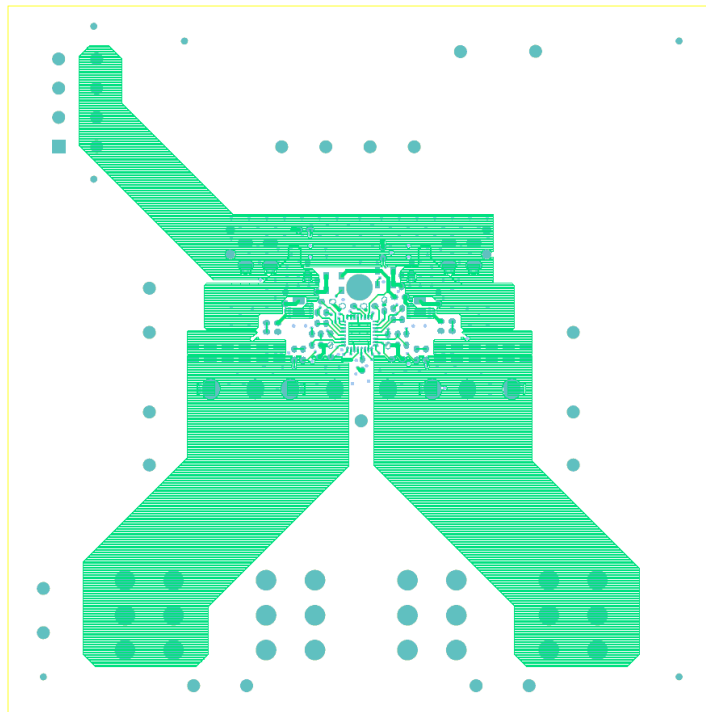
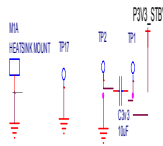

Fig. 11: Board layout, bottom layer.

2.5V and 1.8V / 20A, 350kHz DESIGN



UNLESS OTHERWISE SPECIFIED:
Capacitors are 0603, 10% max, 16V min, XGR min
Resistors are 0603, 1%, 100mW

Input capacitors must support 9.6Ams for 2.5V @ 20A and 1.8V @ 20A

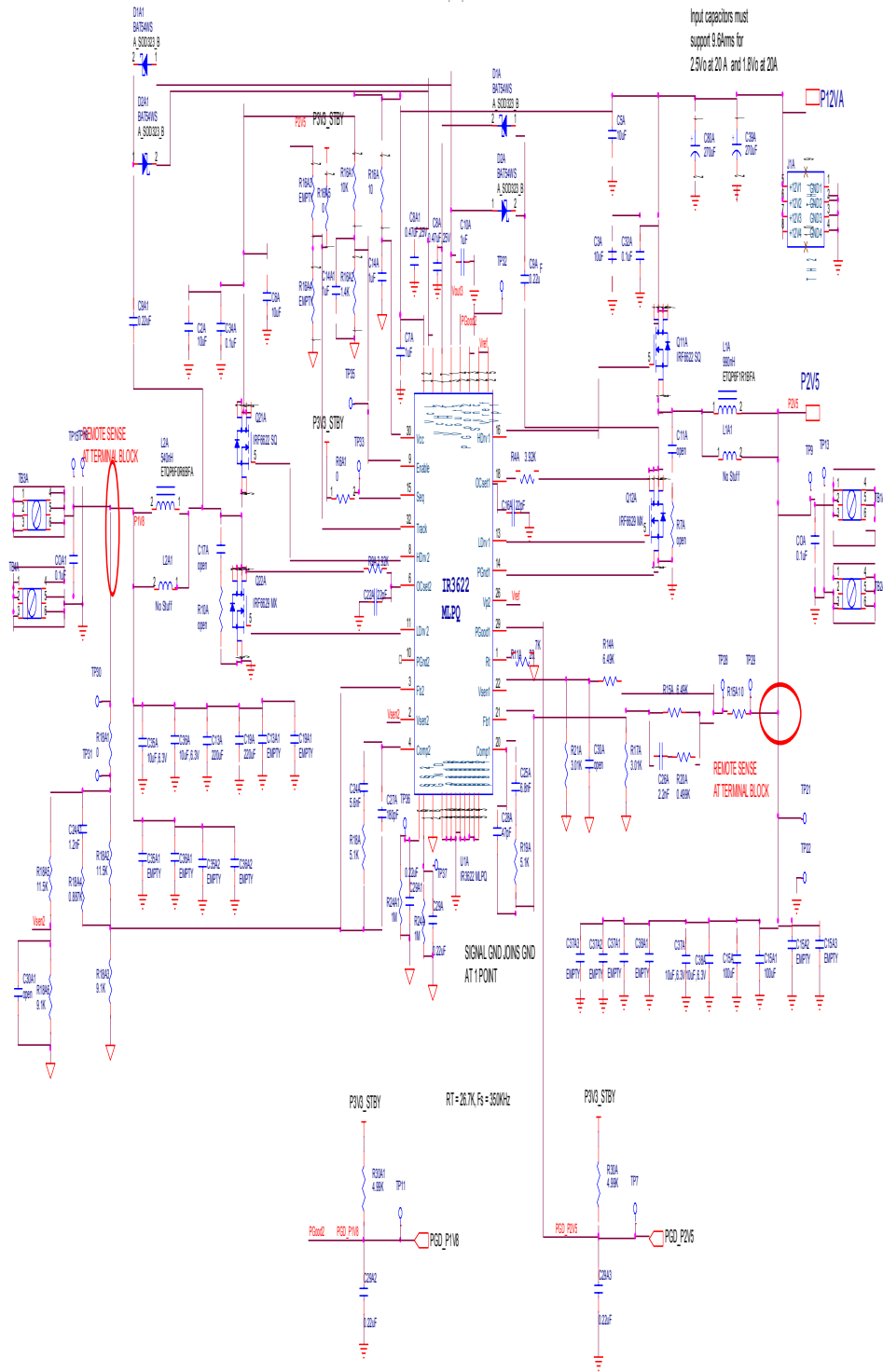

Fig. 12: Schematic of the IRDC3622D board.

BILL OF MATERIALS

Item	Qty	Reference	Value	Description	PCB Footprint	Manufacturer	Part Number
1	4	COA1, C32A, C34A, COA	0.1uF	0.1uF-0603-25V-X7R-10%	A_MC-0603	Panasonic	ECJ1VB1E104
2	2	C30A, C30A1	Open		A_MC-0603		
3	5	C2A, C3A, C5A, C6A, C3v3	10uF	10uF-1206-16V-X7R-20%	A_MC-1206	Murata	GRM31CR61C106KC31L
4	4	C7A, C10A, C14A, C14A1	1uF	1uF-0603-16V-X7R-10%	A_MC-0603	Murata	GRM188R71C105KA12D
5	2	C8A, C8A1	0.47uF	0.47uF-0603-25V-X7R-10%	A_MC-0603	Murata	GRM188R71E474KA12D
6	6	C9A, C29A, C9A1, C29A1, C29A2, C29A3	0.22uF	0.22uF-0603-16V-X7R-10%	A_MC-0603	Panasonic	ECJ1VB1C224
7	2	C11A, C17A	Open		A_MC-0603		
8	2	C13A, C19A	220uF	220uF-D4-2V-9mOhm-SP	A_MC-6MM	Panasonic	EEFSX0D221R
9	2	C15A, C15A1	100uF	100uF-D4-4V-9mOhm-SP	A_MC-6MM	Panasonic	EEFSX0G101R
10	2	C16A, C22A	22pF	22pF-0603-50V-X7R-10%	A_MC-0603	Panasonic	ECJ1VC1H220J
11	1	C24A	5.6nF	5600pF-0603-50V-X7R-10%	A_MC-0603	Panasonic	ECJ1VB1H562K
12	1	C25A	6.8nF	6800pF-0603-50V-X7R-10%	A_MC-0603	Panasonic	ECJ1VB1H682K
13	1	C26A	2.2nF	2200pF-0603-50V-X7R-10%	A_MC-0603	Panasonic	ECJ1VB1H222K
14	1	C27A	180pF	180pF-0603-50V-C0G-5%	A_MC-0603	Panasonic	ECJ1VC1H181J
15	1	C28A	47pF	47pF-0603-50V-C0G-5%	A_MC-0603	AVX	06035A470JAT2A
16	4	C35A, C36A, C37A, C38A	10uF	10uF-0805-6.3V-X5R-10%	A_MC-0805	AVX	08056D106KAT2A
17	2	C39A, C80A	270uF	270uF-8mm-16V	A_MC138-336D	Sanyo	16SEPC270M
18	4	C13A1, C15A2, C15A3, C19A1	Open		A_MC-6MM		
19	1	C24A1	1.2nF	1200pF-0603-50V-X7R-10%	A_MC-0603		
20	8	C35A1, C35A2, C36A1, C36A2, C37A1, C37A2, C37A3, C38A1	Open		A_MC-0805		
21	4	D1A, D2A, D1A1, D2A1	BAT54WS	Schottky,SOD323,30V,0.2A	A_SOD323_B	International Rectifier	BAT54WS
22	1	J1A	ATX8PINS	CONN,8 Pins,2 Rows	PWR2X4	Molex	39299082
23	1	L1A	990nH		A_INDUCT-320	Panasonic	ETQP6F1R1BFA
24	1	L2A	540nH		A_INDUCT-320	Panasonic	ETQP6F0R6BFA
25	2	L1A1, L2A1	Open		IR_PA0513		
26	2	Q11A, Q21A	IRF6622 SQ	IRF6622 SQ 25V	IR_DIRFET_SQ	International Rectifier	IRF6622
27	2	Q12A, Q22A	IRF6629 MX	IRF6629 MX 25V	IR_DIRFET_MX	International Rectifier	IRF6629
28	2	R4A, R9A,	3.92K	RES, 0603, 1%, 1/10W	A_CR-0603	Rohm	MCR03EZPF3922
29	2	R30A, R30A1	4.99K	RES, 0603, 1%, 1/10W	A_CR-0603	Rohm	MCR03EZPF4991
30	2	R7A, R10A	Open		A_CR-0805		
31	1	R11A	26.7K	RES, 0603, 1%, 1/10W	A_CR-0603	Rohm	MCR03EZPF4320
32	4	R6A1, R15A1, R16A5, R18A1	0	RES, 0603, 1%, 1/10W	A_CR-0603	Rohm	MCR03EZPJ000
33	2	R14A, R15A	6.49K	RES, 0603, 1%, 1/10W	A_CR-0603	Rohm	MCR03EZPF6491
34	1	R16A	10	RES, 0603, 1%, 1/10W	A_CR-0603	Panasonic	ERJ-3EKF10R0V
35	2	R17A, R21A	3.01K	RES, 0603, 1%, 1/10W	A_CR-0603	Rohm	MCR03EZPF3011
36	2	R18A, R19A	5.1K	RES, 0603, 1%, 1/10W	A_CR-0603	Yageo	9C06031A5101FKHFT
37	1	R20A	0.499K	RES, 0603, 1%, 1/10W	A_CR-0603	Rohm	MCR03EZPF4990
38	2	R24A, R24A1	1M	RES, 0603, 1%, 1/10W	A_CR-0603	Yageo	RC0603FR-071ML
39	1	R16A1	10k	RES, 0603, 1%, 1/10W	A_CR-0603	Yageo	RC0603FR-0710KL
40	1	R16A2	1.4K	RES, 0603, 1%, 1/10W	A_CR-0603	Panasonic	ERJ-S03F1401V
41	2	R16A3, R16A4	Open		A_CR-0603		
42	2	R18A2, R18A5	11.5K	RES, 0603, 1%, 1/10W	A_CR-0603	Rohm	MCR03EZPF1152
43	2	R18A3, R18A6	9.1K	RES, 0603, 1%, 1/10W	A_CR-0603	Yageo	9C06031A9101FKHFT
44	1	R18A4	0.887K	RES, 0603, 1%, 1/10W	A_CR-0603	Rohm	MCR03EZPF8870
45	4	TB1A, TB2A, TB3A, TB4A	T. BLOCK 1 PIN	Terminal block	TB_1_0	Keystone	8197
46	20	TP37, TP36, TP32, TP33, TP7, TP11, TP17, TP35, TP9, TP13, TP21, TP22, TP15, TP16, TP28, TP29, TP30, TP31, TP1, TP2	TP	Testpoint	V1054_ND	Vector	K24A/M
47	1	U1A	IR3622 MLPQ	Controller	A_MLPQ32-0P5MM_VIA_A	International Rectifier	IR3622
48	1	M1A	Heat Sink	(mm)		ThermaFlo	7201598
49	2	TIM1A, TIM2A	Thermal Interface Material	7.65 x 20.51 (L x W) (mm)		Bergquist	BG420754
50	1	SCRW1A	Philips Pan Head Screw	Stainless A-2(18-8), 2mm x .4 x 5mm		Bolt Depot	6812

TYPICAL OPERATING WAVEFORMS

$V_{in}=12V$, $V_{o1}=2.5V$, $V_{o2}=1.8V$, $I_{o1}=0-20A$, $I_{o2}=0-20A$ $F_s=350$ kHz, Room Temperature, No Air Flow

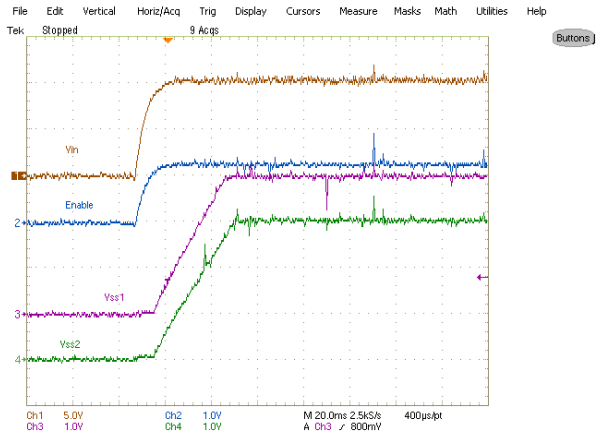

Fig.13: Start-up sequence into 20A Load.
Ch₁: V_{in} , Ch₂: Enable, Ch₃: V_{ss1} , Ch₄: V_{ss2}

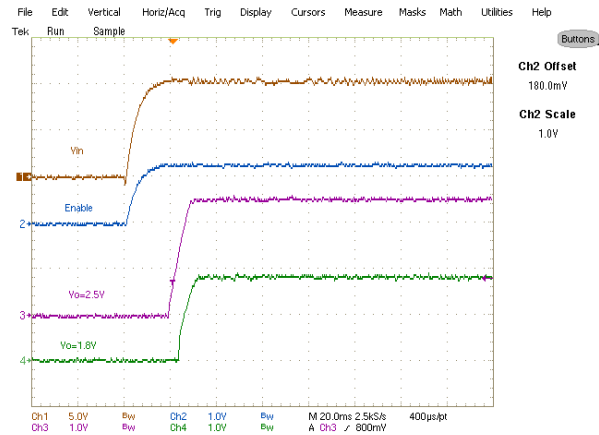

Fig.14: Start-up sequence into 20A load.
Ch₁: V_{in} , Ch₂: Enable, Ch₃: $V_{o1}(2V5)$, Ch₄: $V_{o2}(1V8)$

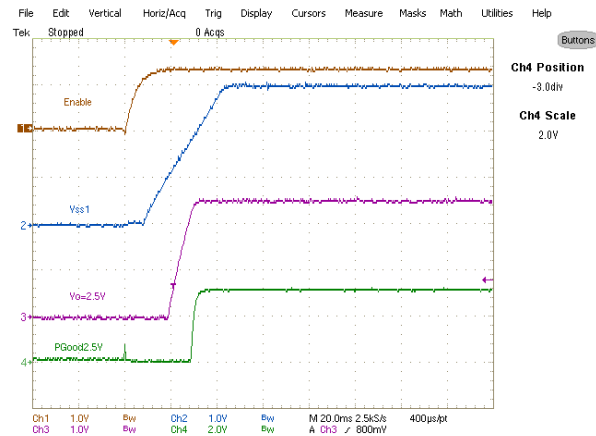

Fig.15: Start-up sequence into 20A load.
Ch₁: Enable, Ch₂: V_{ss1} , Ch₃: $V_{o1}(2V5)$, Ch₄: PGood(2V5)

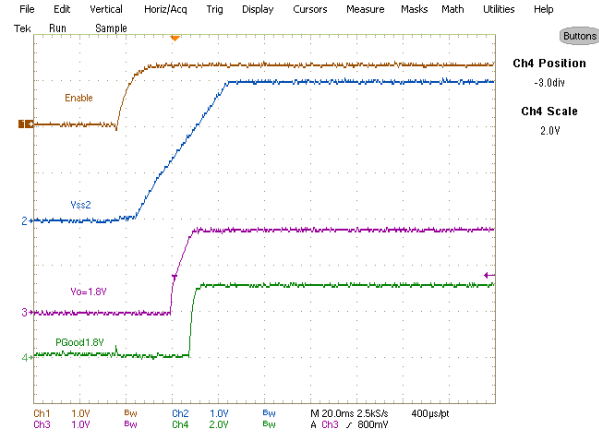

Fig.16: Start-up sequence into 20A load.
Ch₁: Enable, Ch₂: V_{ss2} , Ch₃: $V_{o2}(1V8)$, Ch₄: PGood(1V8)

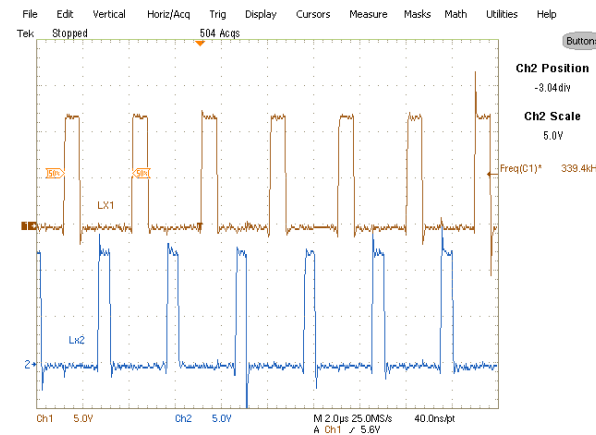

Fig.17: Inductor points.
Ch₁: V_{L1} , Ch₂: V_{L2}

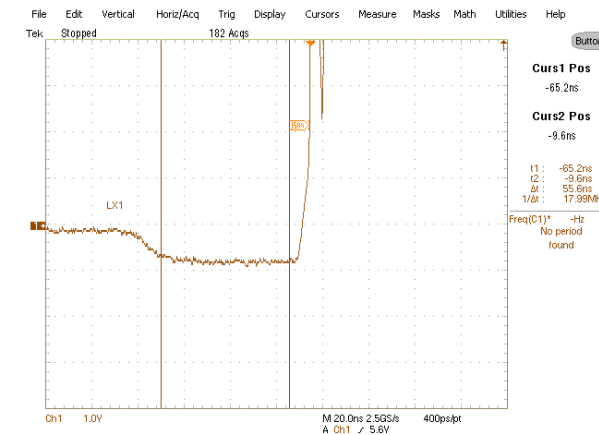

Fig.18: Dead-time (rise) at 20A load.
Ch₁: V_{L1}

TYPICAL OPERATING WAVEFORMS

$V_{in}=12V$, $V_{o1}=2.5V$, $V_{o2}=1.8V$, $I_{o1}=0-20A$, $I_{o2}=0-20A$ $F_s=350$ kHz, Room Temperature, No Air Flow

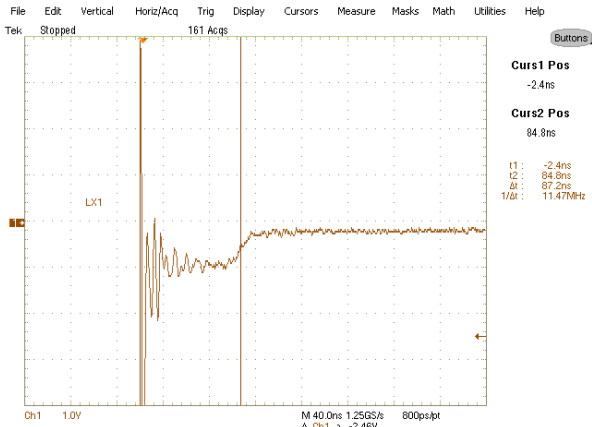

Fig.19: Dead-time (fall) at 20A load.
Ch₁: V_{L1}

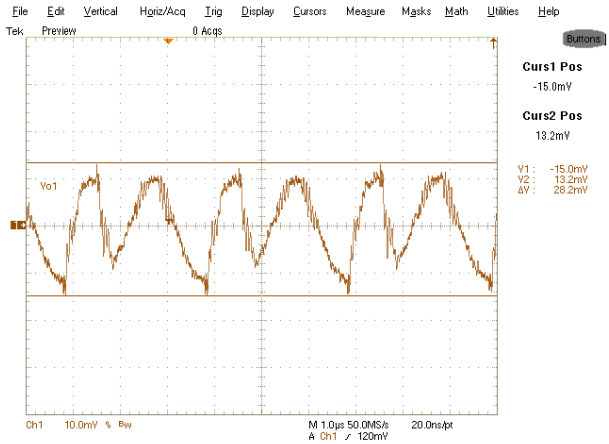

Fig.20: Output voltage ripple at 20A load.
Ch₁: $V_{o1}(2V5)$

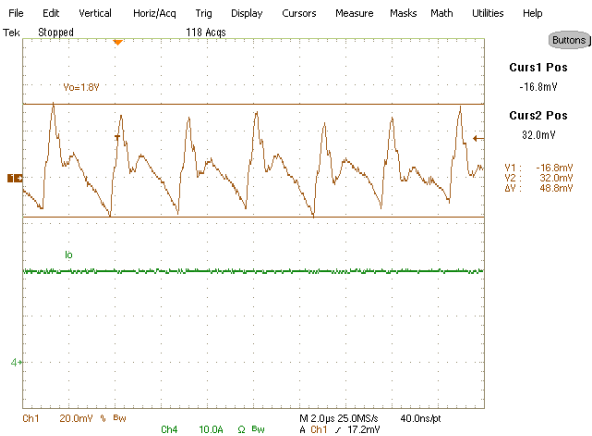

Fig.21: Output voltage ripple at 20A load.
Ch₁: $V_{o2}(1V8)$, Ch₄: I_{o2}

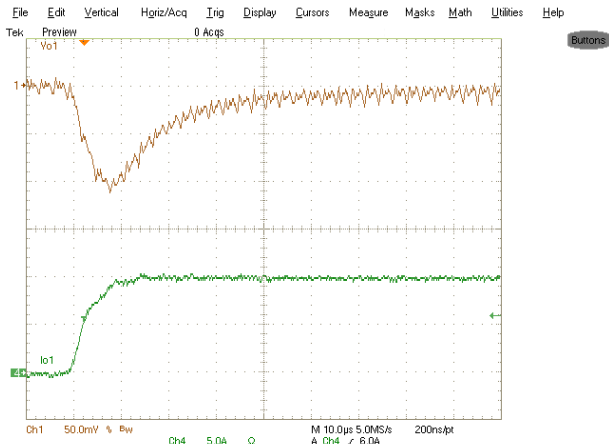

Fig.22: Load transient 0-10A.
Ch₁: $V_{o1}(2V5)$, Ch₄: I_{o1}



Fig.23: Load Transient 10-0A.
Ch₁: $V_{o1}(2V5)$, Ch₄: I_{o1}

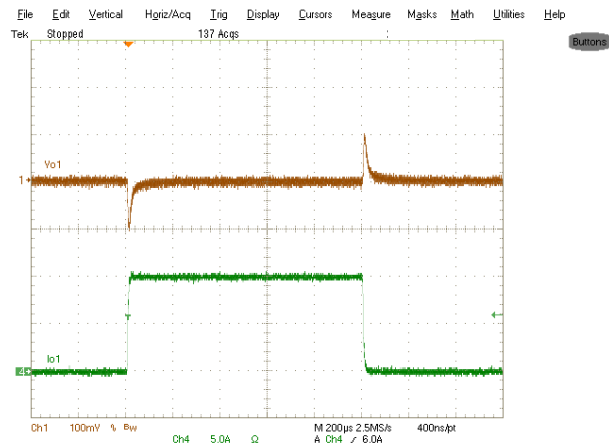

Fig.24: Load Transient 0-10A.
Ch₁: $V_{o1}(2V5)$, Ch₄: I_{o1}

TYPICAL OPERATING WAVEFORMS

$V_{in}=12V$, $V_{o1}=2.5V$, $V_{o2}=1.8V$, $I_{o1}=0-20A$, $I_{o2}=0-20A$ $F_s=350$ kHz, Room Temperature, No Air Flow



Fig.25: Load Transient 0-10A.
Ch₁: V_{o2}(1V8), Ch₄: I_{o2}

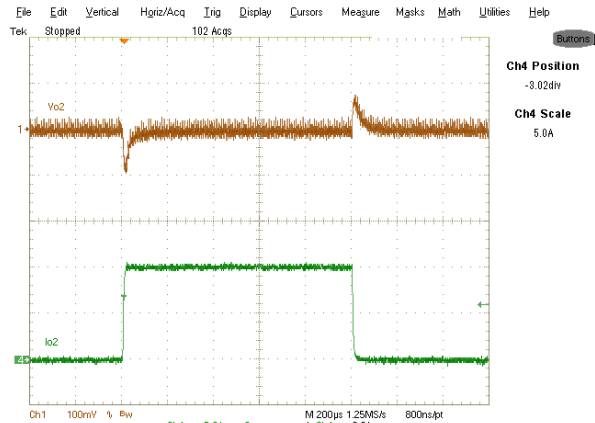

Fig.26: Load Transient 0-10A.
Ch₁: V_{o2}(1V8), Ch₄: I_{o2}

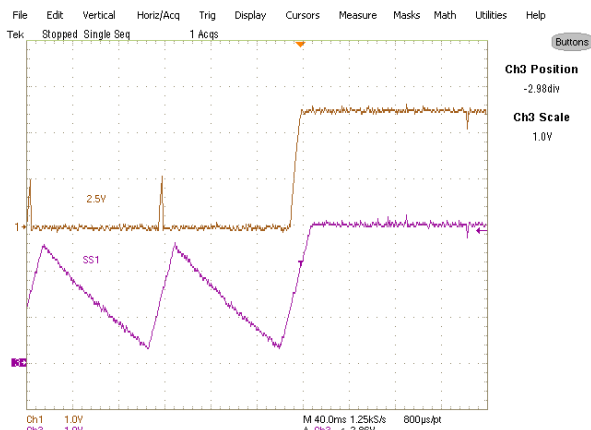

Fig.27: Hiccup Operation
Ch₁: V_{o1}(2V5), Ch₃: V_{SS1}

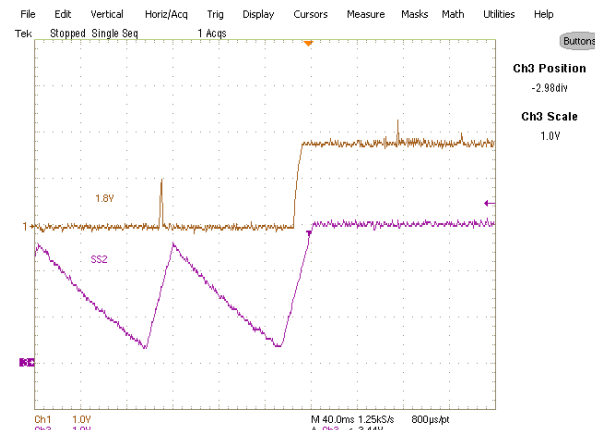

Fig.28: Hiccup Operation
Ch₁: V_{o2}(1V8), Ch₃: V_{SS2}

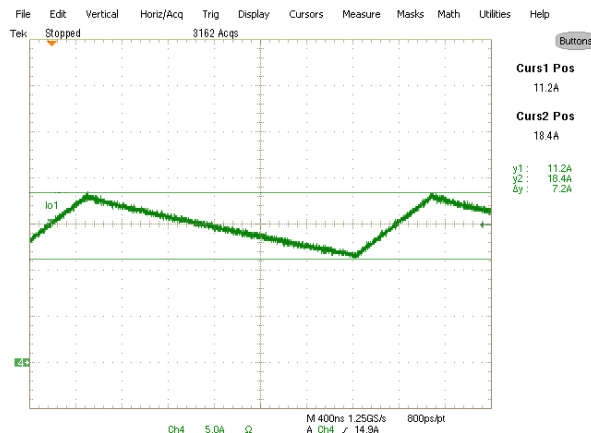

Fig.29: Inductor Current at 15A load
Ch₁: I_{o1}(2V5)

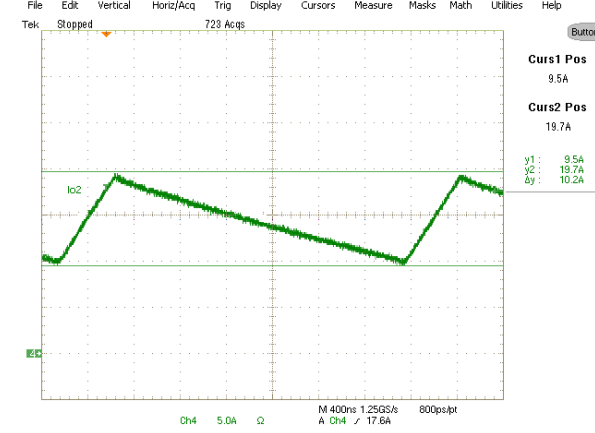

Fig. 30: Inductor Current at 15A
Ch₁: I_{o2}(1V8)

TYPICAL OPERATING WAVEFORMS

$V_{in}=12V$, $V_{o1}=2.5V$, $V_{o2}=1.8V$, $I_{o1}=0-20A$, $I_{o2}=0-20A$ $F_s=350\text{ kHz}$, Room Temperature, No Air Flow

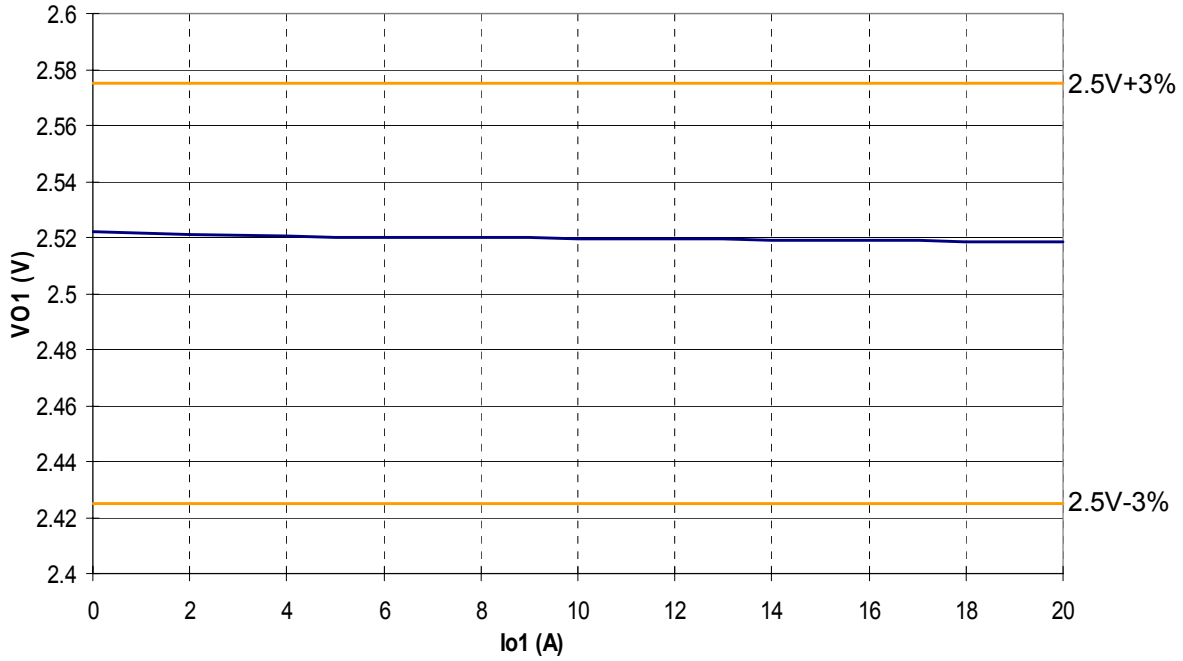

Fig.31: V_{o1} versus its load current.

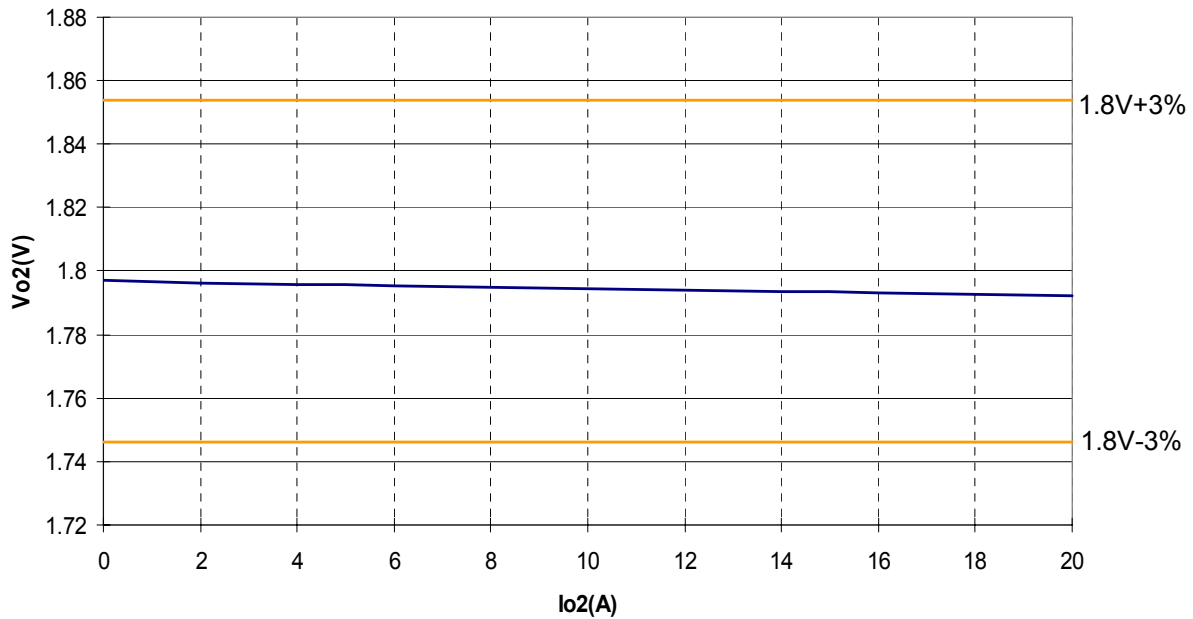

Fig.32: V_{o2} versus its load current.

TYPICAL OPERATING WAVEFORMS

$V_{in}=12V$, $V_{o1}=2.5V$, $V_{o2}=1.8V$, $I_{o1}=0-20A$, $I_{o2}=0-20A$ $F_s=350$ kHz, Room Temperature, No Air Flow

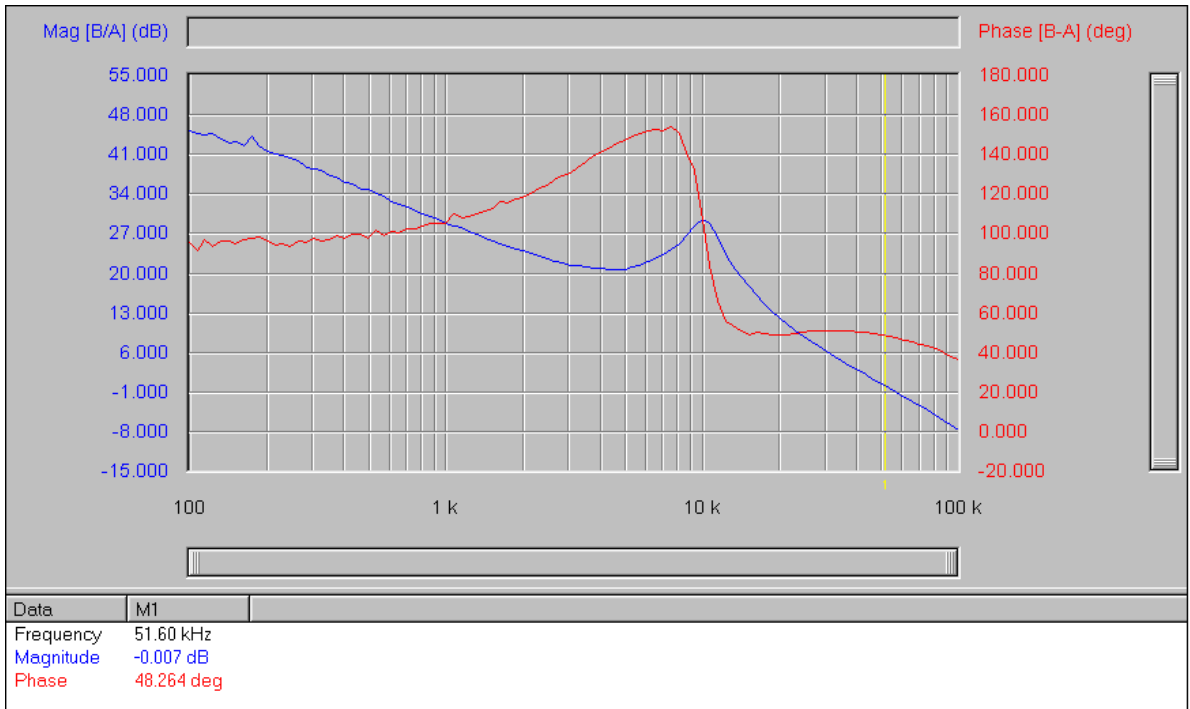

Fig .33: Bode Plot of 2.5V loop at 0A shows a bandwidth of 52kHz and phase margin of 48 degree.

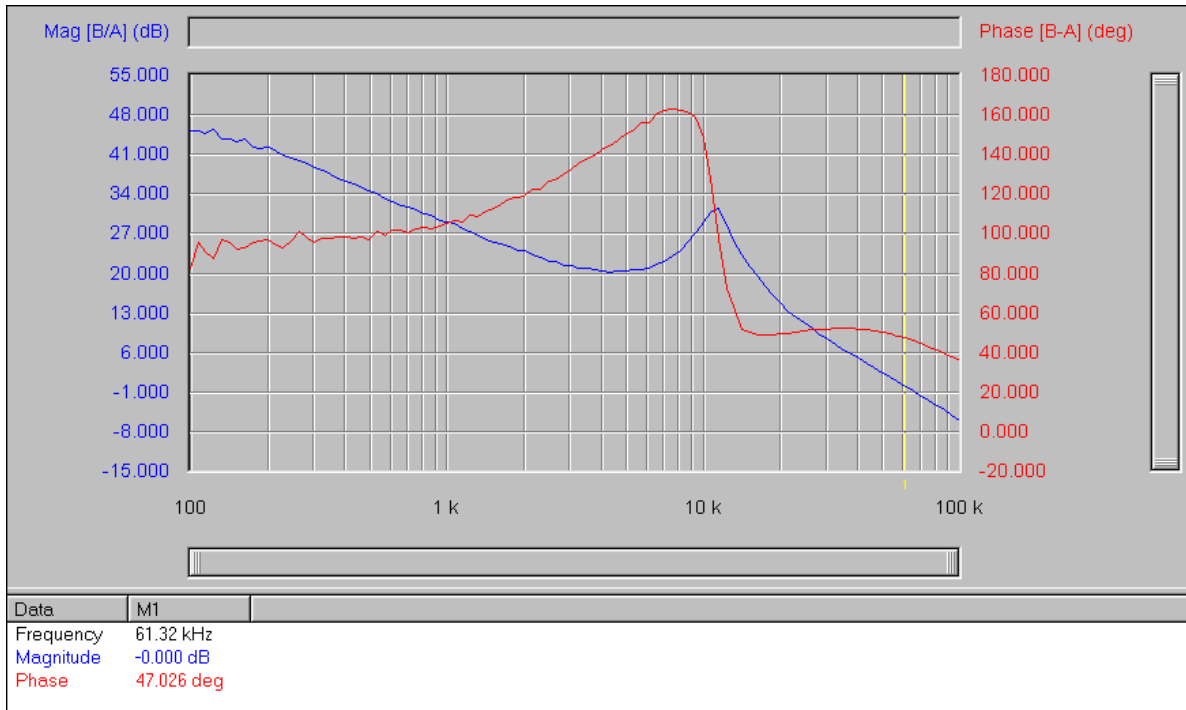

Fig. 34: Bode Plot of 2.5V loop at 20 A shows a bandwidth of 61kHz and phase margin of 47 degree.

TYPICAL OPERATING WAVEFORMS

$V_{in}=12V$, $V_{o1}=2.5V$, $V_{o2}=1.8V$, $I_{o1}=0-20A$, $I_{o2}=0-20A$ $F_s=350$ kHz, Room Temperature, No Air Flow

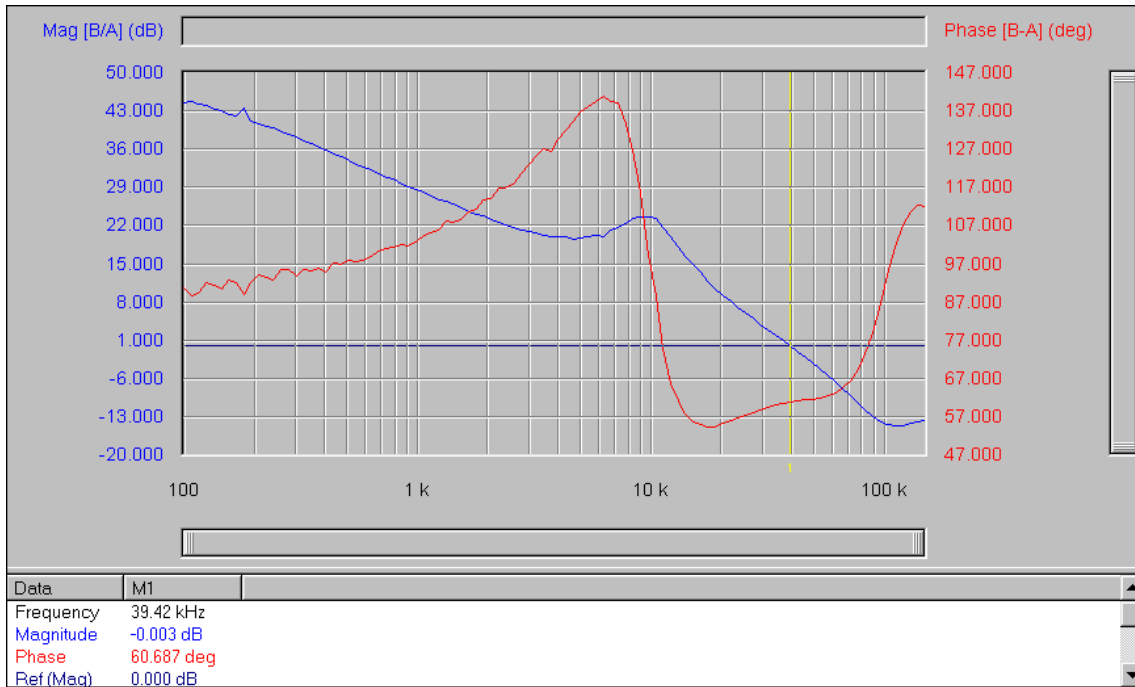

Fig. 35: Bode Plot of 1.8V loop at 0A shows a bandwidth of 39kHz and phase margin of 61 degree.

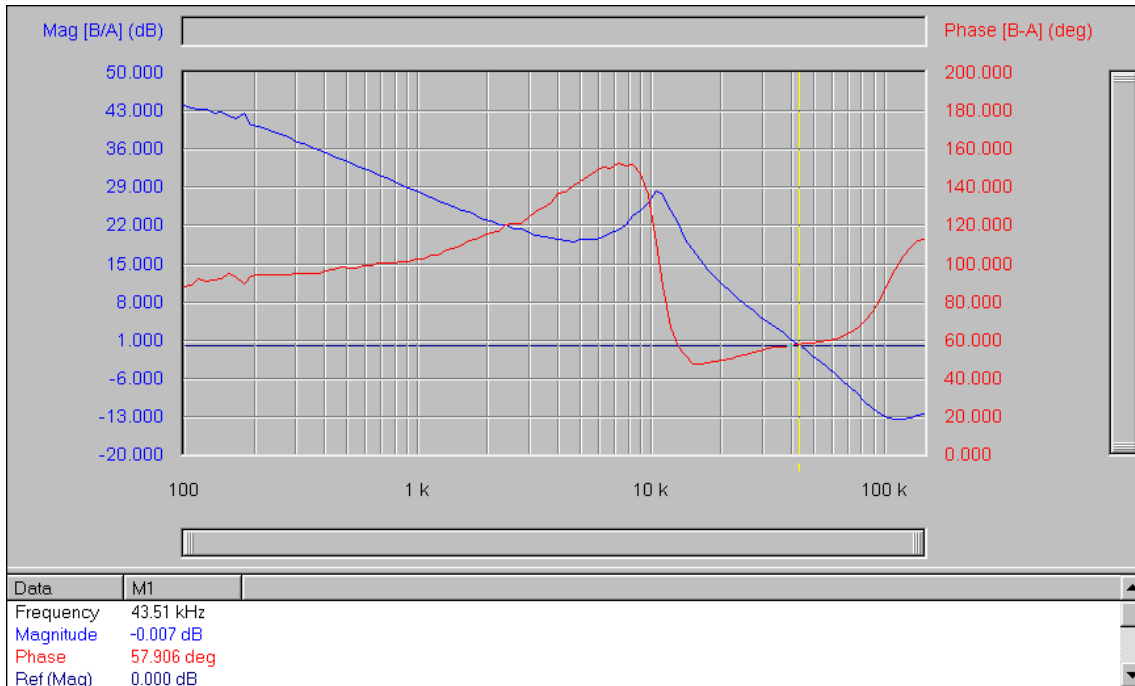

Fig. 36: Bode Plot of 1.8V loop at 20A shows a bandwidth of 43kHz and phase margin of 58 degree.

TYPICAL OPERATING WAVEFORMS

$V_{in}=12V$, $V_{o1}=2.5V$, $V_{o2}=1.8V$, $I_{o1}=0-20A$, $I_{o2}=0-20A$ $F_s=350\text{ kHz}$, Room Temperature, No Air Flow



Fig.37: Thermal Image, Test Points 1, 2, 3, and 4 are Synchronous DirectFET for 2.5V output, Synchronous DirectFET for 1.8V output, Control DirectFET for 2.5V output, and Control DirectFET for 1.8V output, respectively.

TYPICAL OPERATING WAVEFORMS

$V_{in}=12V$, $V_{o1}=2.5V$, $V_{o2}=1.8V$, $I_{o1}=0-20A$, $I_{o2}=0-20A$ $F_s=350\text{ kHz}$, 45°C , 200LFM Air Flow

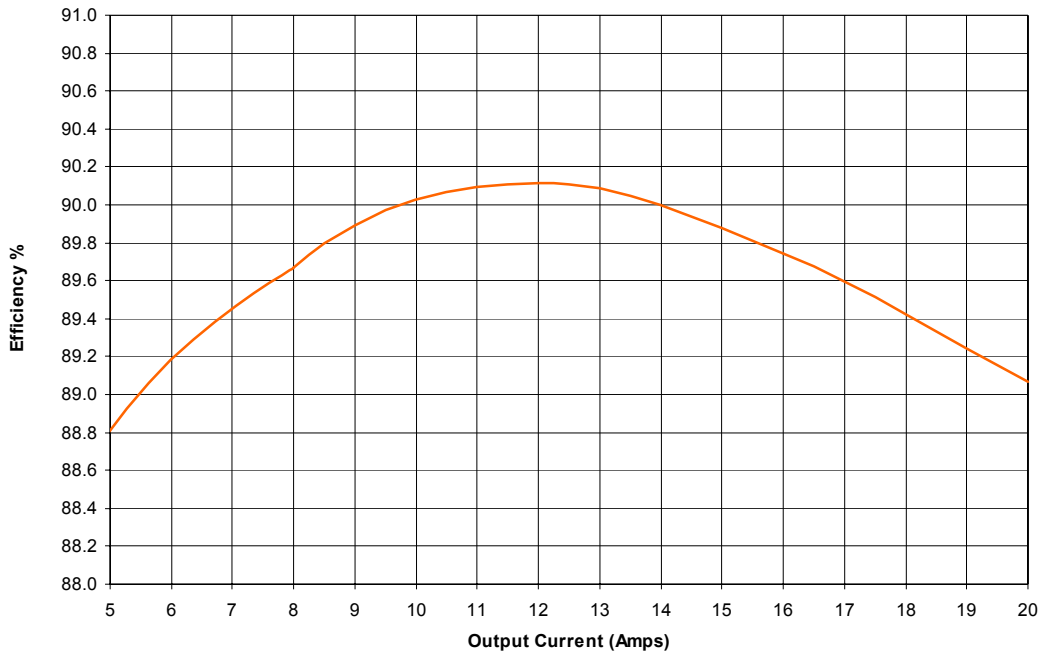

Fig. 38: Efficiency of 2.5V channel versus load current with 200LFM air flow and heat sink at 45°C .

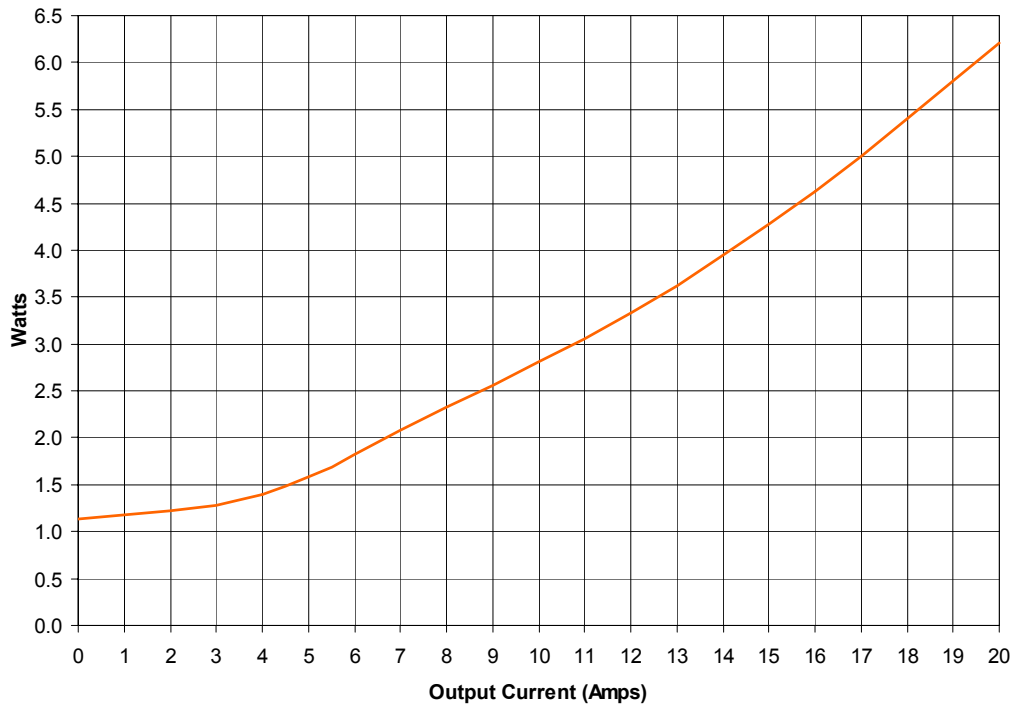

Fig.39: Power loss of 2.5V channel versus load current with 200LFM air flow and heat sink at 45°C .

TYPICAL OPERATING WAVEFORMS

$V_{in}=12V$, $V_{o1}=2.5V$, $V_{o2}=1.8V$, $I_{o1}=0-20A$, $I_{o2}=0-20A$ $F_s=350\text{ kHz}$, 45°C , 200LFM Air Flow

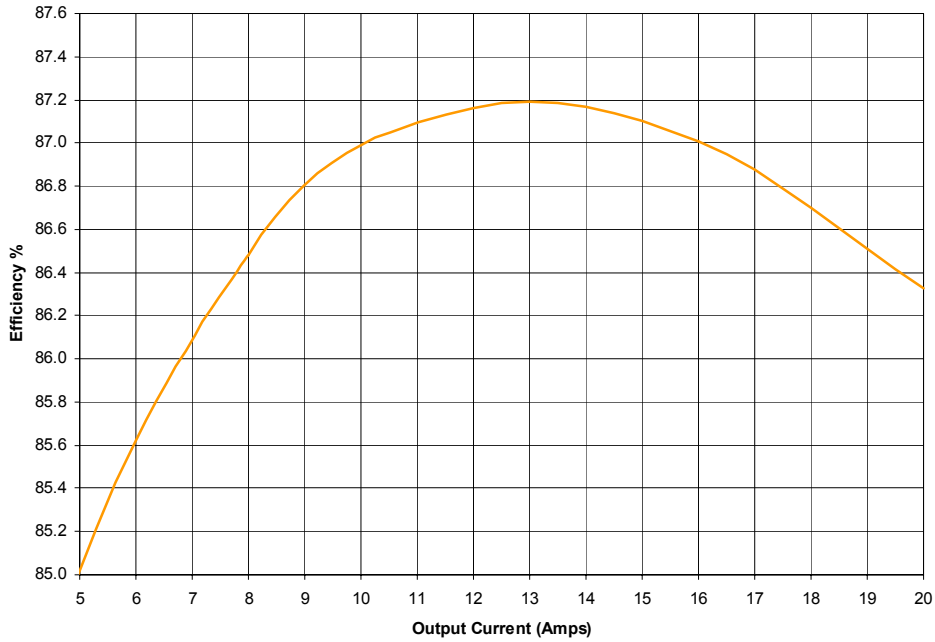

Fig.40: Efficiency of 1.8V channel versus load current with heat sink and 200LFM air flow at 45°C.

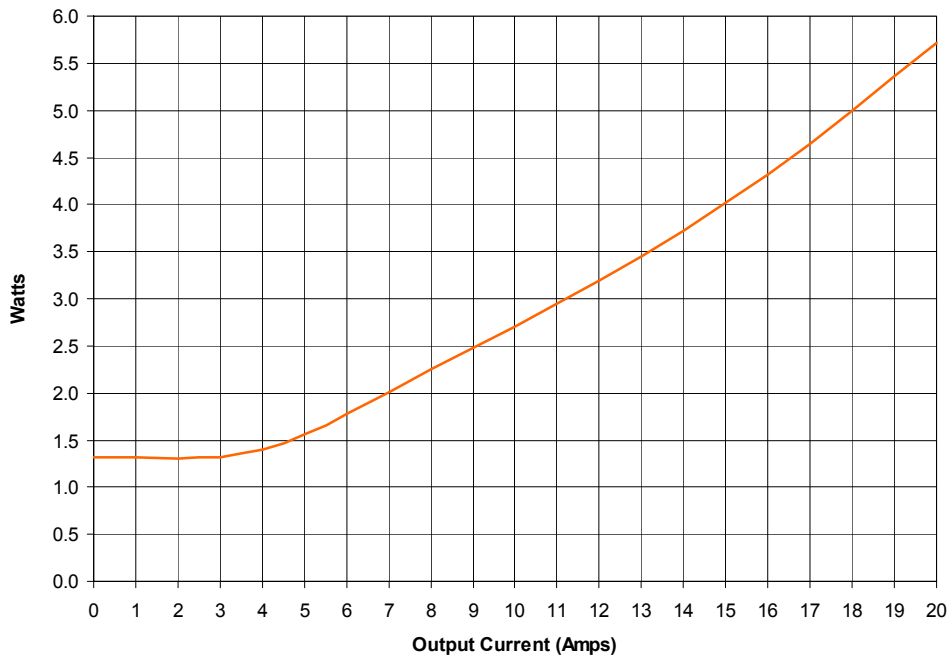

Fig.41: Power loss of 1.8V channel versus load current with heat sink and 200LFM air flow at 45°C.

FREQUENCY SYNCHRONIZATION

$V_{in}=12V$, $V_{o1}=2.5V$, $V_{o2}=1.8V$, $I_{o1}=0-20A$, $I_{o2}=0-20A$, Room Temperature, No Air Flow

The switching frequency of channels can be synchronized by applying a digital input signal to the Sync pin of the IR3622. This frequency of input is twice as the switching frequency of the channels.

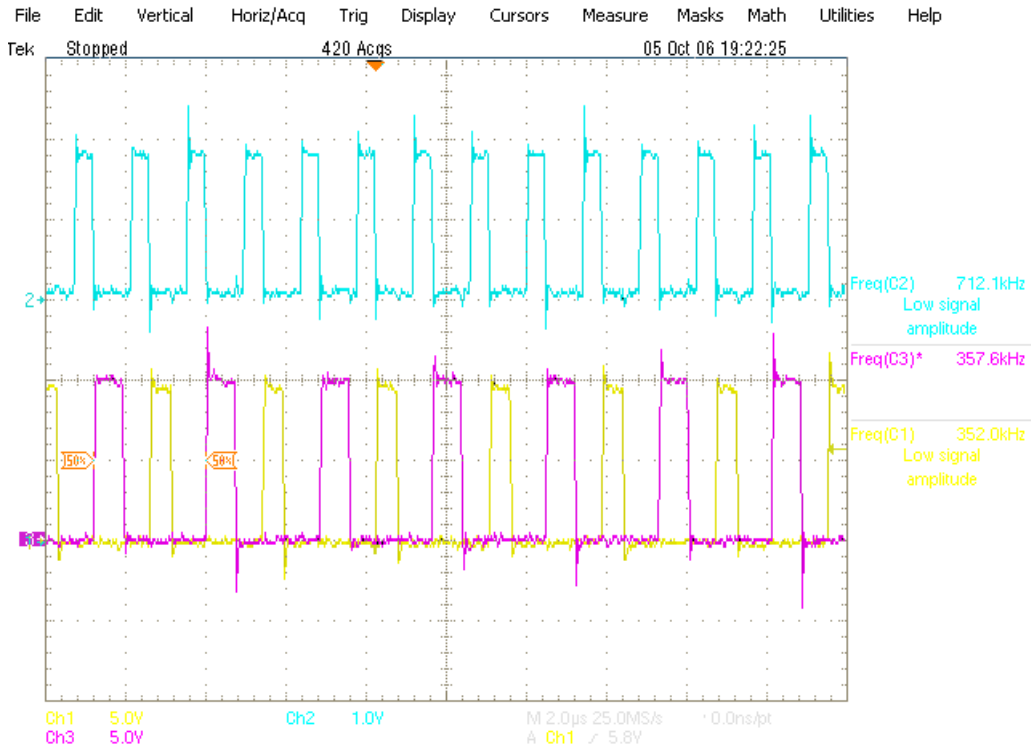

Fig.42: Frequency Synchronization.
Ch₁: V_{L1}(2V5) Ch₂: Sync pin Ch₃: V_{L2}(1V8)

OUTPUT VOLTAGE TRACKING AND SEQUENCING

$V_{in}=12V$, $V_{o1}=2.5V$, $V_{o2}=1.8V$, $I_{o1}=0-20A$, $I_{o2}=0-20A$, Room Temperature, No Air Flow

In order to run the IR3622 in the ratio-metric mode, the following steps should be taken:

- Remove C29A1, R24A1, R6A1, R16A5 from the board.
- Set the value of R16A3 and R16A4 as R15A (6.49K) and R17A (3.01K), respectively.
- Connect TP33 to the SEQ input signal.

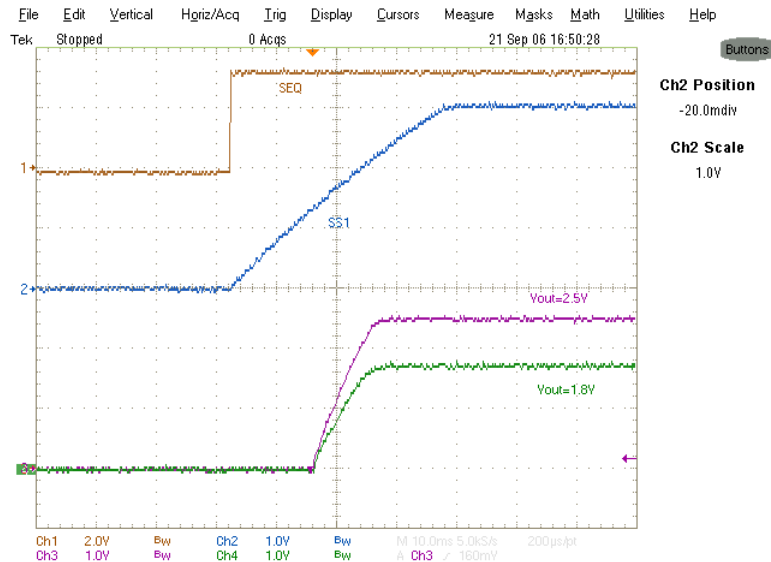

Fig.43: Ratio-metric tracking at the voltage rise to a 20A load.
Ch₁: SEQ Ch₂: V_{SS1} Ch₃: V_{o1}(2V5) Ch₄:V_{o2}(1V8)

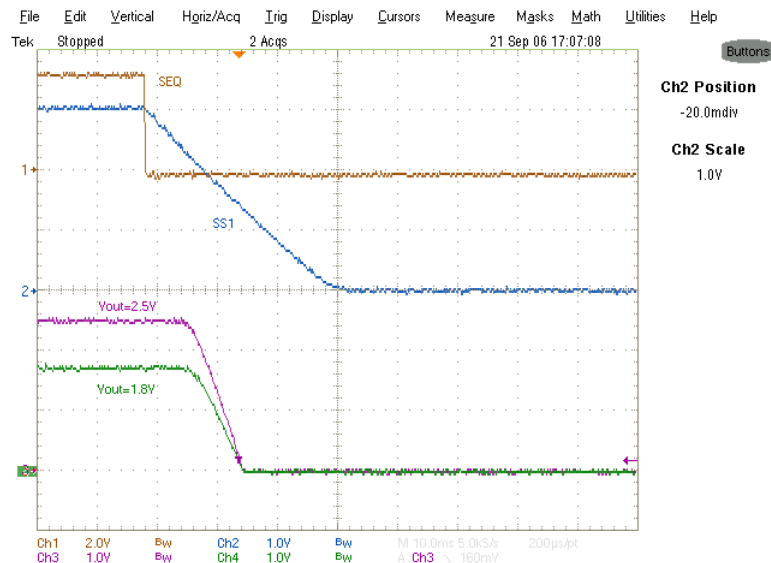

Fig.44: Ratio-metric tracking at the voltage fall with a 20A load.
Ch₁: SEQ Ch₂: V_{SS1} Ch₃: V_{o1}(2V5) Ch₄:V_{o2}(1V8)

OUTPUT VOLTAGE TRACKING AND SEQUENCING

$V_{in}=12V$, $V_{o1}=2.5V$, $V_{o2}=1.8V$, $I_{o1}=0-20A$, $I_{o2}=0-20A$, Room Temperature, No Air Flow

In order to run the IR3622 in the simultaneously mode, the following steps should be taken:

- Remove C29A1, R24A1, R6A1, R16A5 from the board.
- Set the value of R16A3 and R16A4 as R18A2 (11.5K) and R18A3 (9.1K), respectively.
- Connect TP33 to the controlling input signal.

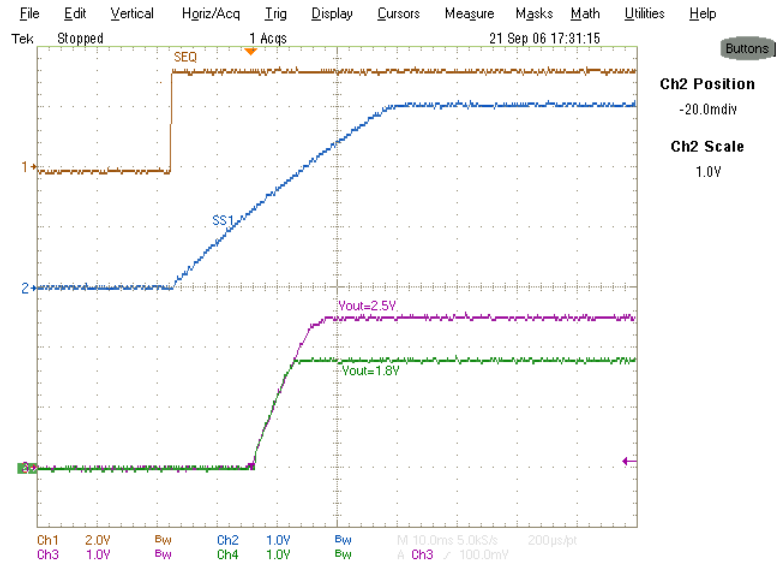

Fig.45: Simultaneously Tracking at the voltage rise to a 20A load
Ch₁: SEQ Ch₂: V_{SS1} Ch₃: V_{o1}(2V5) Ch₄:V_{o2}(1V8)

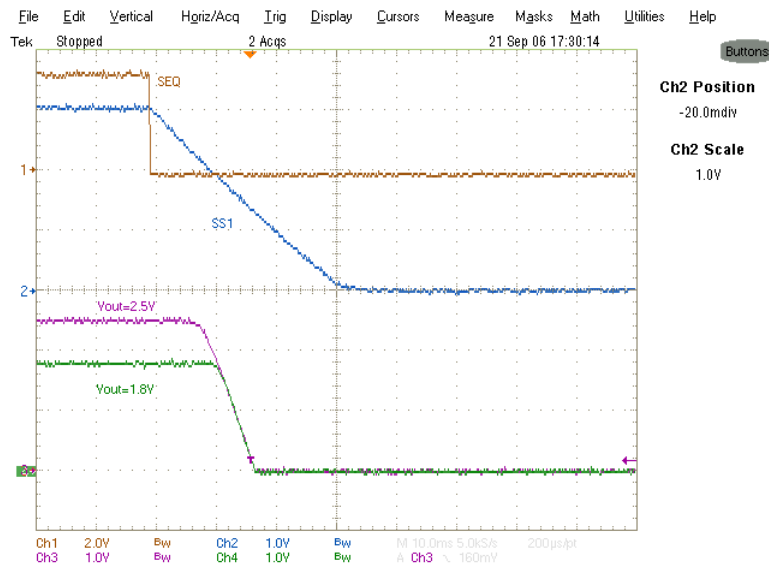
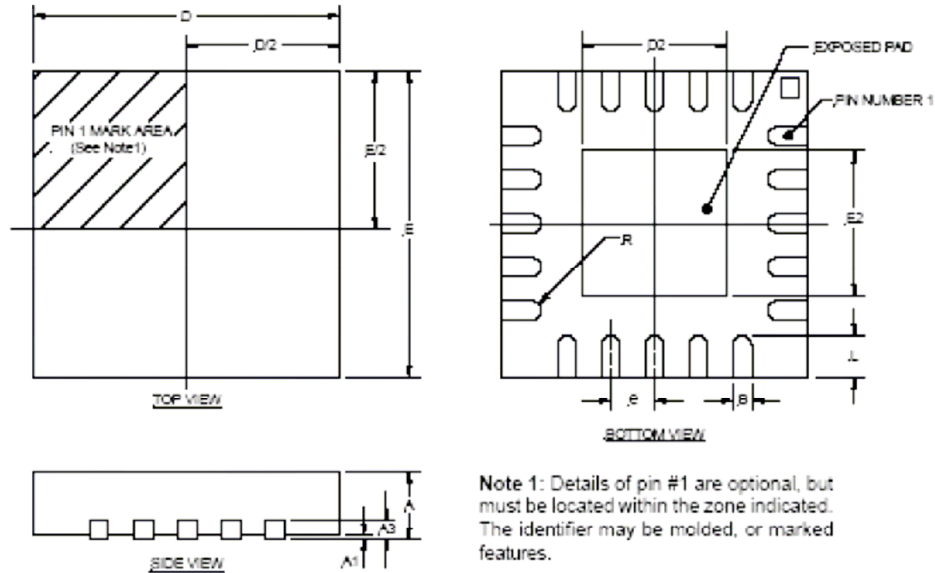

Fig.46: Simultaneously Seq. at the voltage fall with a 20A load
Ch₁: SEQ Ch₂: V_{SS1} Ch₃: V_{o1}(2V5) Ch₄:V_{o2}(1V8)

(IR3622M) MLPQ Package; 5x5-32 Lead



SYMBOL	32-PIN 5x5		
	MIN	NOM	MAX
A	0.80	0.90	1.00
A1	0.00	0.02	0.05
A3	0.20 REF		
B	0.18	0.23	0.30
D	5.00 BSC		
D2	3.30	3.45	3.55
E	5.00 BSC		
E2	3.30	3.45	3.55
e	0.50 BSC		
L	0.30	0.40	0.50
R	0.09	---	---

NOTE: ALL MEASUREMENTS ARE IN MILLIMETERS.

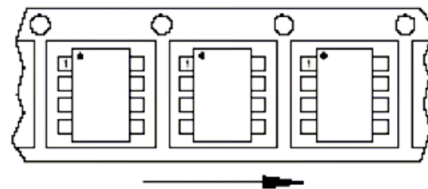

Feed Direction
 Figure A

IR WORLD HEADQUARTERS: 233 Kansas St., El Segundo, California 90245, USA Tel: (310) 252-7105
 TAC Fax: (310) 252-7903

This product has been designed and qualified for the Industrial market.

Visit us at www.irf.com for sales contact information

Data and specifications subject to change without notice. 01/23/2007